

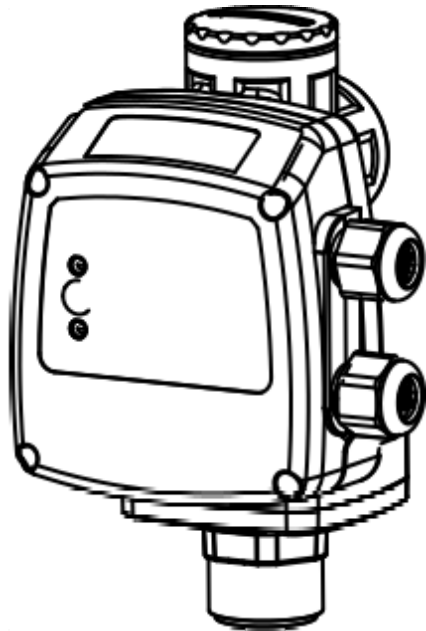

TEEPRES®

ELECTRONIC PUMP CONTROLLER

USER MANUAL



Technical changes, misprints and mistakes reserved!



1. INTRODUCTION

TEEPRES® is a device that starts and stops the pump to which it is fitted, thus replacing traditional pressure switch / surge tank systems. The pump is started when, as a tap is turned on, the pressure within the system drops below the "start-up pressure" (Pm), and is stopped when the flow rate required is zero or less than the "shut-off flow rate" (Qa). TEEPRES®'s electronics protect the pump against unsuitable operating conditions such as dry running or repeated start-ups due to leaks. TEEPRES® features two threaded 1" BSP female outlets, positioned at 90° the one to the other, to be able to directly fit an expansion tank to the device; this is useful in case of any system drips, to prevent the continual restart of TEEPRES®.

2. SAFETY REGULATIONS

Before installing or using TEEPRES®, read this manual carefully and thoroughly. The pump should be installed and serviced by qualified personnel, responsible for making the hydraulic and electrical connections in compliance with the relevant regulations. 1A PROFI HANDELS GMBH shall not be held liable for any damage relating to, or resulting from, an improper use of the product, or for any damage relating to, or resulting from, servicing or repairs carried out by unqualified personnel and/or with non-OEM spare parts. The warranty, which is valid for 24 months from the date of purchase, will no longer be applicable should the product suffer damage as a consequence of the use of non-OEM spare parts, tampering or improper use.

When starting the installation, check the following:

- the power supply is switched off
- the power lines can withstand the maximum current
- the cable bushings and circuit board cover have been properly assembled and secured (see Electrical Connections).
- the power supply is fitted with regulation earthing and safety devices.

When servicing the product, check the following:

- the system is not pressurised (turn a tap on)
- the power supply is switched off

Emergency Stop

When in use, the pump can be stopped in the event of an emergency: press START / STOP. TEEPRES® is out of service.

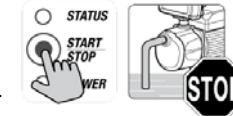

3. OPERATING CONDITIONS

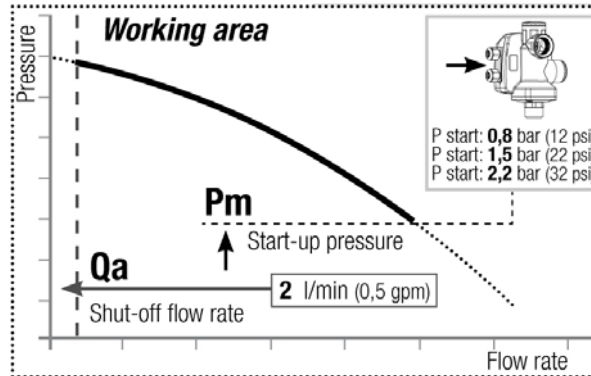

A. Compatible / non compatible fluids

TEEPRES® is suitable for use with clean water and chemically non-aggressive liquids. If the fluid contains impurities, a filter should be fitted upstream.

B. Environmental conditions

TEEPRES® should not be used where there is the risk of an explosion. The temperature of the location should range between 0°C and 65°C, and the humidity should not exceed 90%.

C. Power supply

Make sure that the variation in the power supply is never more or less than 10 % of the RATING value. Higher values may cause damage to the electronic components. TEEPRES® can only be used with single-phase pumps.

4. INSTALLATION

Preliminary checks

- Take the TEEPRES® out of the packaging and check the following:
- check for damage,
 - check the RATINGS correspond with those required,
 - that the cable bushings and screws are in place,
 - that TEEPRES®'s inlets and outlets are clean and free of any packaging materials
 - that the check valve moves smoothly

Hydraulic connections Orientation

TEEPRES® can be installed at any angle depending on the flow direction, as indicated in the diagrams

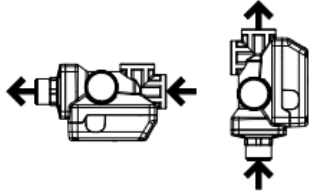

Position

TEEPRES® can either be fitted directly to the pump outlet or anywhere along the delivery line. Never install taps between the pump and TEEPRES®. Do not install a non-return valve between TEEPRES® and the taps, meanwhile it is possible, although not necessary, to install a non-return valve on the suction piping of the pump.

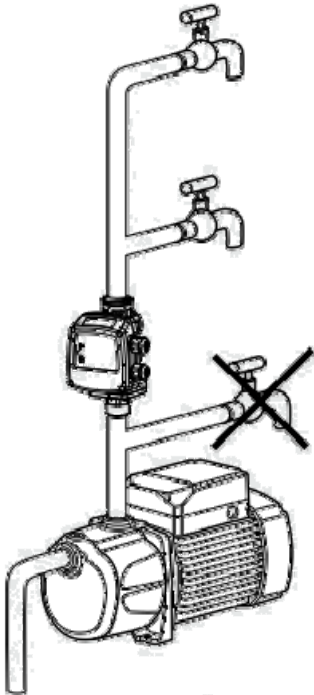

!!! ATTENTION !!!

The pressure applied by the water column above TEEPRES® must not exceed that of the pump start-up pressure (Pm).

!!! ATTENTION !!!

The maximum pressure produced by the pump must be at least 1-1.5 bar (15 psi) higher than the start-up pressure (Pm). If the pressure produced by the pump is too low, TEEPRES® will stop the pump and indicate a 'dry running' error message.

Electrical Connections

The electrical connections should be made as indicated in the Diagram which can also be found on the inside of the circuit Cover. ATTENTION! The cable bushings and circuit board cover must be properly assembled and secured in order to guarantee IP65 grade protection of the electrical components.

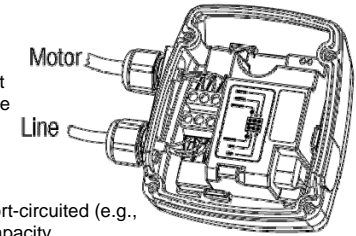

External enabling inlet (e.g., level sensor):

this is an optional function, with NO logic, for connecting a clean contact which disables the system if the terminals are not short-circuited (e.g., open level signal). The connected contact must have 1 A minimum capacity. To connect the cable to the terminals, drill the cover in the dedicated area, with diameter suitable for fitting the feedthrough provided.

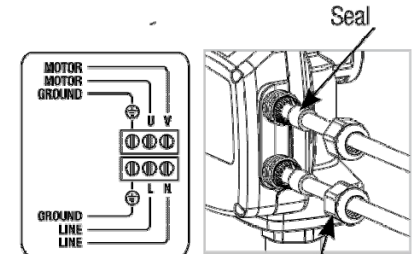

NOTES

DRY RUNNING = there is no flow and the pressure is lower than that of the pump start-up pressure (Pm). It occurs when there is no water. After 15 seconds TEEPRES® stops the pump and indicates an ERROR message. TEEPRES® AUTOMATICALLY tries to resume NORMAL SERVICE at intervals of increasing time (15, 30, 60 minutes and successively once every hour). If TEEPRES® detects any pressure and/or flow, NORMAL SERVICE is resumed, otherwise, the pump is stopped again until the next attempt is made. A MANUAL attempt to resume NORMAL SERVICE can be made at any time.

FREQUENT START-UP = the repeated stopping and starting of the pump at intervals of less than 2 minutes from each other. This occurs when the flow rate is less than 2 litres/min (0,5 gpm). This may cause damage to the pump. In the event of leaks or extended use at excessively low flow rates (less than 2 litres/min (0,5 gpm)), the pump may be started/stopped as often as once every few seconds, putting the pump at risk of damage. In this case, after about 30 minutes, TEEPRES® stops the pump for the following 30 minutes (in order to let it cool down) and indicates an ERROR message. If the time interval between the starts-stops is more than 10 seconds (and therefore poses less of a risk to the pump), TEEPRES® will allow the pump to be used for more than 30 minutes. Once that enough time has passed to allow the pump to cool down it is restarted AUTOMATICALLY. The pump may be restarted MANUALLY any time.

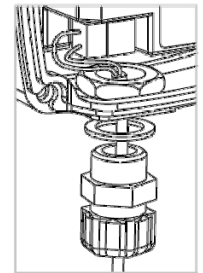

5. First start-up

Priming the pump

For instructions on how to prime (fill) the pump, see the pump manual.

Attention

TEEPRES® is fitted with a check valve: do not use the TEEPRES®'s outlet to fill the pump for priming.

Switching the pump on

The red (Power) LED lights up; TEEPRES® instantly detects that there is no pressure within the system and starts the pump (the green 'Status' LED lights up). If, within 15 seconds of starting up, TEEPRES® does not detect the correct priming of the pump, it stops the pump and indicates a 'dry running' error message.

Attention

When the pump is started for the first time, it may have to be run for longer in order to the priming procedure.

Press the START/STOP button

to restart the pump and complete the priming procedure.

6. Operation

○ = Off ● = On  ● ● ● ● ● ● = Flashing  ● ● ● ● ● ● = Flashing

1. No power supply

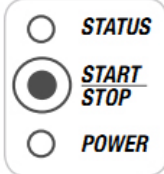

TEEPRES® is switched off.

Press briefly or hold down = nothing happens

Power is restored = TEEPRES® resumes NORMAL SERVICE and starts the pump (if necessary)

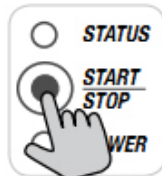

2a. NORMAL SERVICE: the pump is inactive.

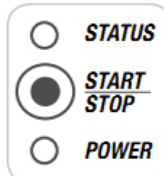

The system is pressurised. All taps are turned off. There is no demand for water. TEEPRES® detects an assembly pressure higher than that of the start-up pressure (Pm) and no flow.



Press briefly = the pump is started manually and runs for a few seconds before stopping again.

Hold down = the pump is put OUT OF SERVICE. For instructions on how to reactivate the pump, see point 3.

A tap is turned on = as soon as the pressure falls below the start-up pressure (Pm), the pump is started.

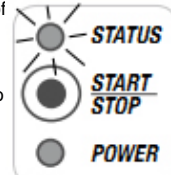
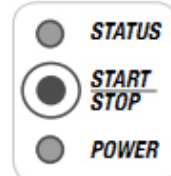

2b. NORMAL SERVICE: the pump is running

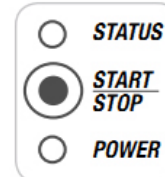

The assembly requires water. One or more taps are turned on. TEEPRES® detects a flow; the assembly pressure is normally higher than the START-UP pressure, but it may also be lower



Press briefly or hold down =

The pump is stopped and put OUT OF SERVICE.

For instructions on how to reactivate the pump, see point 3

The taps are turned off =

if there is no flow for a few seconds, the pump is stopped.

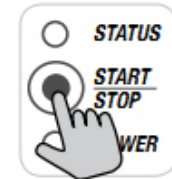

3. OUT OF SERVICE

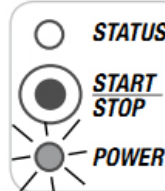

The pump has been stopped manually. The pump will remain inactive until a new command is given.

Press briefly = nothing happens

Hold down = the pump resumes NORMAL SERVICE. See points 2a-2b.

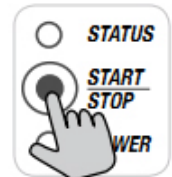

4a. ERROR: stopped temporarily due to DRY RUNNING

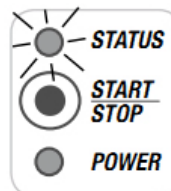

(see NOTE 1)

TEEPRES® has detected that the pump is dry running and has therefore stopped it TEMPORARILY.

Press briefly

= the pump is started manually and resumes NORMAL SERVICE. See points 2a-2b.

Hold down

= the pump is put OUT OF SERVICE.

For instructions on how to reactivate the pump, see point 3

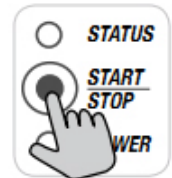

4b. ERROR: temporary shut down due to FREQUENT START-UP

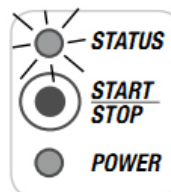

(see NOTE 2)

TEEPRES® has detected that the pump starting-up too often and has therefore stopped it TEMPORARILY.

Press briefly

= the pump is started manually and resumes NORMAL SERVICE. See points 2a-2b.

Hold down

= the pump will not restart and goes OUT OF ORDER.

The pump is OUT OF SERVICE. For instructions on how to reactivate the pump, see point 3.

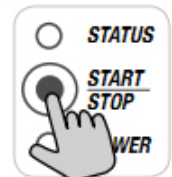

7. TROUBLESHOOTING

Problems	Signals	Possible causes	Solutions
PRESFLO® will not turn on		No power	Check the electrical connections
The pump will not start when a tap is turned on		PRESFLO® model with an inadequate start-up pressure (Pm) for the chosen application.	Relocate PRESFLO® to another position Install a model with a higher start-up pressure (Pm)
		Faulty electrical connections or pump out of service	Check the electrical connections and that the pump is working
		PRESFLO® "OUT OF SERVICE"	Reset PRESFLO® (See Operation, point 3).
		PRESFLO® in temporary shut down due to "DRY RUNNING" due to lack of water	Wait for the automatic restart or press START to restart manually (See Operation, point 4a)
		Maximum pump pressure is insufficient	Replace the pump with one with more suitable characteristics Install a model with a lower start-up pressure (Pm)
The pump delivers no or low pressure		Filters or pipes may be partly blocked	Check the water pipes
		PRESFLO®'s valve will not open completely	Check that the valve is not blocked by any foreign objects and clean if necessary
The pump stops and starts repeatedly		Leaks within the system (less than the shut-off flow rate Qa)	Check the hydraulic connections and repair any leaks. If a leak cannot be repaired, install an expansion tank
The pump will not stop		The flow rate is higher than the shut-off flow rate (Qa)	Make sure that all taps are turned off and that there are no leaks within the system
		PRESFLO®'s check valve will not close	Check that the valve is not blocked by any foreign objects and clean if necessary

○ = Off ● = On = Flashing

8. EXPLODED VIEW OF SPARE PARTS

- 1 – TEEPRES® body
- 2 – Cover with TEEPRES® board
- 3 – Valve unit
- 4 – Pressure gauge
- 5 – Cable gland

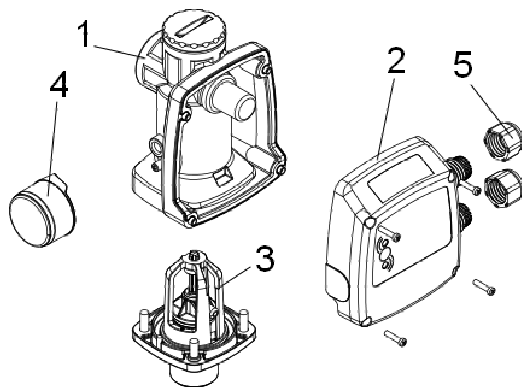

9. Size (mm)

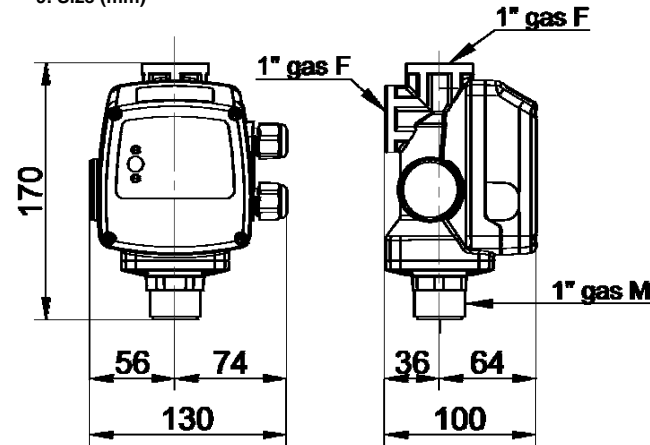

10. Technical specifications

- Voltage: 230 Volt a.c / 110 Volt a.c.
- Frequency: 50-60Hz
- Maximum current: 12 / 16A
- Protection grade: IP 65
- Operating pressure (Pm): 0,8 / 1,5 / 2,2 Bar (12 / 22 / 32 PSI)
- Stop capacity (Qa): 2 l/Min. (0,5 GPM)
- Suction connection: 1" M BSP
- Supply connections (2): 1" F BSP
- Max operating pressure: 10 bar (150 PSI)
- Burst pressure: 40 bar (580 PSI)
- Max ambient temperature: 50°C (+120°F)
- Weight: 550g

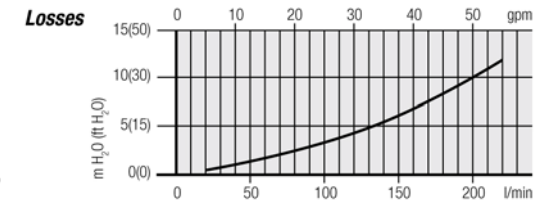

11. UMWELTINFORMATION / ENVIRONMENTAL INFORMATION

After the end of the period of use, the device is compliant to a disposal conform of electrical trash-regulations, so that the materials contained in the device can be environmentally friendly recycled and reused.

We are listed at the German registry EAR under the WEEE no. DE25523173.

Imprint



1A Profi Handels GmbH

www..profi-pumpe.de
Email: info@1a-profi-handel.de
Tel.: (+49) 0611-945877600
Fax: (+49) 0611-9458776911